

- A** PORTANUMERO 67x23cm
Ogni pannello sarà applicato in orizzontale sul bordo d'attacco di ogni portiera anteriore, IL NUMERO SUL DAVANTI. La cima del pannello dovrà trovarsi tra i 7 e i 10 cm al di sotto del limite inferiore del finestrino

- B** Pubblicità 35x15cm da applicare dove richiesto

- C** Placca concorrente 43x22cm da applicare sul cofano

- D** 3 copie del numero di gara, arancione, da apporre sui finestrini laterali posteriori, e sul lunotto posteriore, 24cm di altezza

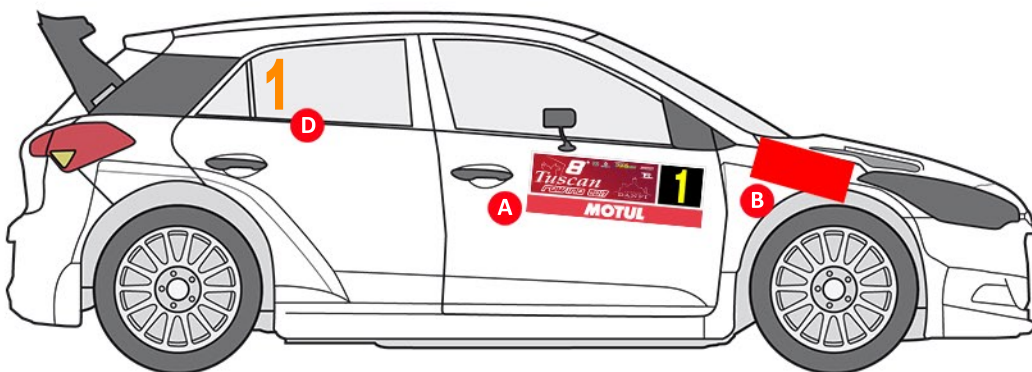
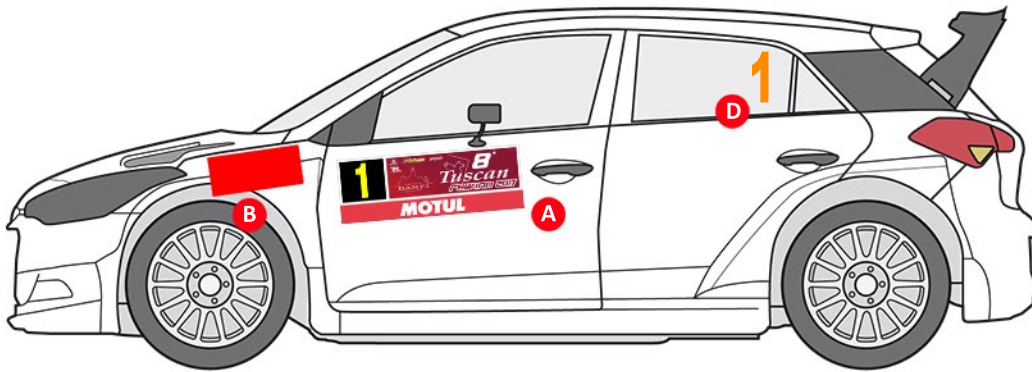
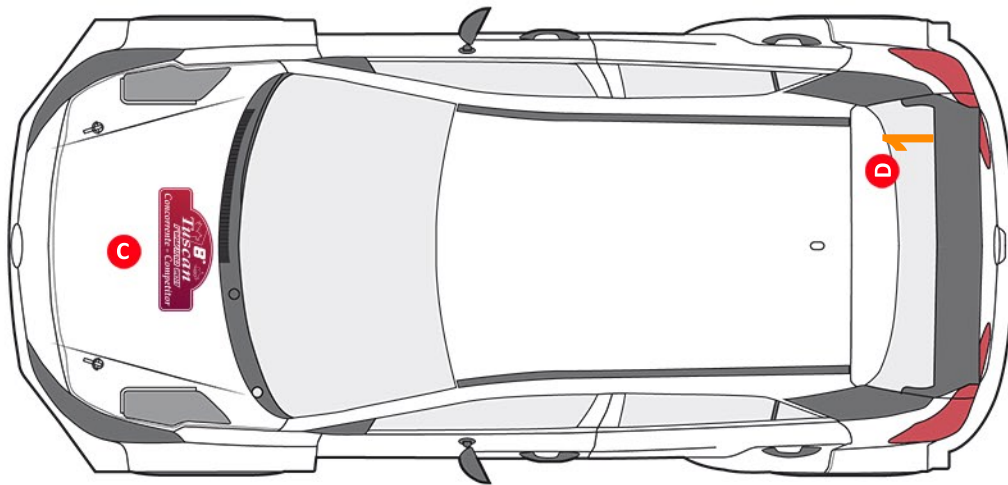

- A** NUMBER 67x23cm
Each panel will be applied horizontally on the front edge of each front door, THE NUMBER ON THE FRONT. The top of the panel should be between 7 and 10 cm below of the lower limit of the window
- B** Advertising 35x15cm where indicated
- C** "competitor" 43x22cm in hood of the car
- D** 3 race number copies , oranges, to apply in side windows, and in rear window, 24cm height